

HVAC Controls For System Integrators



neptronic®



Overview

Neptronic features a wide range of BTL listed BACnet MS/TP or Modbus networked controllers that have proven integration with several BMS systems on multiple sites around the world. Neptronic networkable controllers offer flexibility and simplicity within any integration strategy to provide:

- Seamless integration and interoperability
- Real-time information management and control
- Lower costs and higher value
- Diverse control strategies
- Higher energy conservation

Save Time On Integration, Installation and Commissioning

Neptronic networkable controllers feature some or all of the following features and benefits.



Two MAC Address Configuration Methods

Set MAC address via user friendly menu on thermostat or locally on unit via DIP switches.



Firmware Upgrade via BACnet

Upgrade the device in the field via BACnet. Initiate the upgrade during normal operation and choose when to restart the system.



Auto Configuration and Detection

The controller automatically configures its device instance to a default value + MAC address. The controller automatically configures its baud rate by detecting the network speed upon connection.



Programming Schedules

Determine occupancy in advance for 7 days with up to 6 events per day. Avoid constant monitoring and save energy.



Copy Configuration

Copy the controller's entire configuration and broadcast it to other controllers of the same type on the same network.



Automatic Update of Changed Values

Enable subscription to update changed values automatically. Avoid regular polling of values, reduce traffic and transmit faster.



BACnet Objects

Multiple BACnet Objects per controller enable you to read/write information as you monitor and trend status of operation, alarms and schedules.



Service Display

If you are searching for a specific device, enabling the service mode will flash the device to easily locate the device.

**UMCP Frederick Hall,
Maryland (USA)**



AUTOMATEDLOGIC
United Technologies

370 TFCB
Wall mount controllers

**Wilson Project,
Sidney, OHIO (USA)**



BUILDINGLOGIX
BUILDING SYSTEMS INTERNATIONAL

65 EVCB
Controllers

**International Civil Aviation Organization (ICAO),
Montreal, Quebec (Canada)**



Delta
CONTROLS
A Delta Group Company

1100 EVCB
Controllers

**INTEL PTK-1 R&D Center,
Petach Tikva (Israel)**



700 EFCB
Controllers

**Rashid Hospital,
Dubai (UAE)**



Honeywell

240 EVCB
Controllers

**Funan Digitalife Mall,
Singapore**



**Johnson
Controls**

950 TUCB
450 CMMB106
Controllers

**Google Offices Tel-Aviv,
Israel**



**Schneider
Electric**

700 EFCB
Controllers

**Jurong Port,
Singapore**



**Schneider
Electric**

700 EVCB
Controllers

**Landmark 81,
Vietnam**



SIEMENS

700 EVCB
Controllers

**Palm Tower,
Qatar**



TREND

1600 EVCB
Controllers

**World Business Center
Heathrow Airport London (UK)**



TRIDIUM

200 EFCB
Controllers

**Google Campus,
India**



TRIDIUM

350 EVCB
Controllers



ASHRAE **BACnet™**

Modbus



Fan coil unit controller (EFCB) with Digital Room Sensor (TDF)



Inputs

DI4

4 Digital*

AI6

6 Analog*



24Vac
120/240Vac

Outputs

B08

4 TRIACs
Up to 4 Digital*

A04

4 Analog*



1, 2, or 3* Speed
or ECM

Communication

BAC

BACnet
MS/TP

*Configurable

Mod

Modbus
RTU Slave



Room Sensor
3 Wires (Digital)

Models

Model	Type	Extra 3A Relay
EFCB10TU2	24Vac	2
EFCB10TU4		4
EFCB11TU2	120Vac	2
EFCB11TU4		4
EFCB12TU2	240Vac	2
EFCB12TU4		4
Middle East and Asian Markets		
EFCB10T-OE1	24Vac	0
EFCB10TU2-OE1		2
EFCB10TU4-OE1		4
EFCB12T-OE1	240Vac	0
EFCB12TU2-OE1		2
EFCB12TU4-OE1		4

Controller (EFCB)

- Real Time Clock (RTC) with 24 hour backup
- Configurable PI (Proportional-Integral) function
- Selectable proportional control band and dead band
- Independent cool/heat setpoint for NSB/OCC mode
- Selectable internal or external temperature sensor (10KΩ)
- Change over by contact or external temperature sensor
- Freeze protection
- BACnet MS/TP or Modbus communication (selectable)
- BACnet scheduler
- Firmware upgradeable via BACnet
- 4 AI can be configured as Dry Contacts
- Digital room sensor with onboard or external CO₂ sensor with integrated logic
- ECM with Enable/Disable option

Applications

- 2 or 4 pipe systems
- Fan coil unit (up to 3 speeds and/or analog 0-10Vdc)
- Cooling signal (on/off, floating or modulating 0-10Vdc)
- Heating signal (on/off, floating, pulse or modulating 0-10Vdc)
- Reheat signal (on/off, floating, pulse or modulating 0-10Vdc)



NEW



Models

Horizontal Models	Temp.	RH	CO ₂
<ul style="list-style-type: none"> ● TDF10-100 ● TDF40-100 ○ TDF70-100 	•		
<ul style="list-style-type: none"> ● TDF10-101 ● TDF40-101 ○ TDF70-101 	•	•	
<ul style="list-style-type: none"> ● TDF10-102 ● TDF40-102 ○ TDF70-102 	•	•	•
<ul style="list-style-type: none"> ● TDF10-103 ● TDF40-103 ○ TDF70-103 	•		•

Vertical Models	Temp.	RH	CO ₂	PIR	VOC
<ul style="list-style-type: none"> ● TDF00-100 ● TDF30-100 ○ TDF60-100 	•				
<ul style="list-style-type: none"> ● TDF00-101 ● TDF30-101 ○ TDF60-101 	•	•			
<ul style="list-style-type: none"> ● TDF00-102 ● TDF30-102 ○ TDF60-102 	•	•	•		
<ul style="list-style-type: none"> ● TDF00-104 ● TDF30-104 ○ TDF60-104 	•			•	
<ul style="list-style-type: none"> ● TDF00-105 ● TDF30-105 ○ TDF60-105 	•	•		•	
<ul style="list-style-type: none"> ● TDF00-106 ● TDF30-106 ○ TDF60-106 	•	•	•		•
<ul style="list-style-type: none"> ● TDF00-107 ● TDF30-107 ○ TDF60-107 	•	•	•	•	•

Universal Digital Room Sensor (TDF)

- Built-in temperature sensor and optional humidity, CO₂, VOC and occupancy sensors (select models)
- Elegant design
- Universal wall-mount design
- Used to configure and operate the EFCB Fan Coil controllers
- Three wire connection between digital room sensor and controller
- Selectable Fahrenheit or Celsius scale
- BACnet service port via on-board mini USB connector
- Horizontal or vertical configuration

TSUB



Fan Coil Wall Mount Controller

NEW



Inputs

A12

2 Analog*
(Universal)



24Vac

Outputs

B05

5 Binary*

A02

2 Analog*



1, 2, or 3* Speed
or ECM

Communication

BAC

BACnet
MS/TP

Mod

Modbus
RTU Slave

*Configurable

Models

Models	Temp.	RH	PIR
<ul style="list-style-type: none"> ● TSUB00-100 ● TSUB30-100 ○ TSUB60-100 	•		
<ul style="list-style-type: none"> ● TSUB00-101 ● TSUB30-101 ○ TSUB60-101 	•	•	
<ul style="list-style-type: none"> ● TSUB00-104 ● TSUB30-104 ○ TSUB60-104 	•		•
<ul style="list-style-type: none"> ● TSUB00-105 ● TSUB30-105 ○ TSUB60-105 	•	•	•

Main Features

- Optional internal/external humidity sensor input for simple and accurate humidity control
- Internal/external occupancy input
- Dehumidification sequence compensated by auto activation of reheat output
- Real time clock (RTC) with 24-hour backup
- Precise temperature control with configurable PI (Proportional-Integral) function
- Selectable internal or external temperature sensor
- Low limit set protection (10°C/50°F)
- Occupancy and night set back (NSB) mode
- Selectable direction on outputs
- Option of pulse/floating/on-off output on binary outputs
- Compressor anti-cycling delay (configurable)
- ΔT control (on request)
- Selectable BACnet MS/TP or Modbus communication
- Selectable Fahrenheit or Celsius scale
- Multi level lockable access menu and setpoint

TSU



Fan Coil Standalone Wall Mount Controller

NEW



Inputs

A12

2 Analog*
(Universal)



24Vac

Outputs

B05

5 Binary*
**Configurable*

A02

2 Analog*



1, 2, or 3* Speed
or ECM

Main Features

- Optional internal/external humidity sensor input for simple and accurate humidity control
- Internal/external occupancy input
- Dehumidification sequence compensated by auto activation of reheat output
- Precise temperature control with configurable PI (Proportional-Integral) function
- Selectable internal or external temperature sensor



Models

Models	Temp.	RH	PIR
● TSU00-100 ● TSU30-100 ○ TSU60-100	•		
● TSU00-101 ● TSU30-101 ○ TSU60-101	•	•	
● TSU00-104 ● TSU30-104 ○ TSU60-104	•		•
● TSU00-105 ● TSU30-105 ○ TSU60-105	•	•	•

CCC



Fan Coil Relay Interface Board



Models

Model	Voltage	Contact Ratings		Number of Outputs
		Resistive	Motor	
CCC713-07	120 Vac	7 A	1/4 HP	3
CCC714-07				4
CCC715-07				5
CCC723-07	240 Vac	7 A	1/4 HP	3
CCC724-07				4
CCC725-07				5

Main Features

- 240/120 Vac
- 3, 4 or 5 contacts
- Metal box with secure 4-point mounting (models without enclosure also available)
- Equipped with built-in transformer (12VA max)

Applications

- Ideal for fan coil applications where 240/120 Vac equipment must be controlled by a 24Vac digital room sensor
- Designed to operate with TFC, TUCB, TSU, TSUB and TUUB controllers

EVCB



VAV Unit Controller



VAV unit controller (EVCB) with Digital Room Sensor (TDU)

Inputs

DI2	AI2		
2 Digital*	2 Analog*	Pressure Sensor (select models)	24Vac

Outputs

B04	A02
Up to 4 TRIACs	2 Analog*

Communication

BAC	Mod	
BACnet MS/TP	Modbus RTU Slave	Room Sensor 3 Wires (Digital)
*Configurable		

Models

Model	TRIACS	Pressure Type	Feedback	Fan Powered Box
EVCB14NIT0S	0	Indep.		
EVCB14NIT2S	2	Indep.		
EVCB14NIT4S	4	Indep.		•
EVCB14NDT4S	4	Dep.		•
EVCB14NIT0SF	0	Indep.	•	
EVCB14NIT4SF	4	Indep.	•	•

External Motor

Model	TRIACS	Pressure Type	Motor
EVCB14NIT4X	4	Indep.	External
EVCB14NDT4X	4	Dep.	External

Dual Duct

Model	TRIACS	Pressure Type	Type
EVCBM14NIT2S	2	Indep.	Master Controller
EVCS14N	-	-	Slave Controller

Controller (EVCB)

- Built-in actuator, 70 in.lb. (8Nm) (select models)
- On board differential pressure sensor (select models)
- Simple air balancing and commissioning via digital room sensor
- Automatically sets operation mode to pressure dependent or independent based on the presence of air flow
- Configurable PI (Proportional-Integral) function
- Independent, configurable proportional control band and dead band per ramp
- Selectable internal or external temperature sensor (10KΩ)
- Digital room sensor with on-board or external CO₂ sensor with integrated logic
- Changeover by contact or external temperature sensor
- Real time clock (RTC) with 24-hour backup
- BACnet MS/TP or Modbus communication (selectable)
- BACnet scheduling

Applications

- Single duct, cooling only and/or heating
- Up to 4 stage reheat and/or cool
- Up to 4 On/Off heat and/or cool
- Up to 4 time proportioned (TPM) heat or reheat
- Up to 2 analog (0-10Vdc) reheat and/or cool
- Up to 2 floating heat and/or cool
- Pressure dependent or pressure independent
- With or without auto changeover
- Supply/exhaust (requires an additional EVC)

TDU



VAV Digital Room Sensors

NEW



● TDU10

● TDU40

○ TDU70



● TDU00

● TDU30

○ TDU60

Models

Horizontal Models	Temp.	RH	CO ₂
● TDU10-100 ● TDU40-100 ○ TDU70-100	•		
● TDU10-101 ● TDU40-101 ○ TDU70-101	•	•	
● TDU10-102 ● TDU40-102 ○ TDU70-102	•	•	•
● TDU10-103 ● TDU40-103 ○ TDU70-103	•		•

Vertical Models	Temp.	RH	CO ₂	PIR	VOC
● TDU00-100 ● TDU30-100 ○ TDU60-100	•				
● TDU00-101 ● TDU30-101 ○ TDU60-101	•	•			
● TDU00-102 ● TDU30-102 ○ TDU60-102	•	•	•		
● TDU00-104 ● TDU30-104 ○ TDU60-104	•			•	
● TDU00-105 ● TDU30-105 ○ TDU60-105	•	•		•	
● TDU00-106 ● TDU30-106 ○ TDU60-106	•	•	•		•
● TDU00-107 ● TDU30-107 ○ TDU60-107	•	•	•	•	•

Universal Digital Room Sensor (TDU)

- Built-in temperature sensor and optional humidity, CO₂, VOC and occupancy sensors (select models)
- Elegant design
- Universal wall-mount design
- Used to configure and operate the EVCB VAV controllers
- Three wire connection between digital room sensor and controller
- Selectable Fahrenheit or Celsius scale
- BACnet service port via on-board mini USB connector
- Horizontal or vertical configuration

TRO24/TRO54



VAV Wall Mount Controller



TRO24



Combination VAV controller and room thermostat.
Run control wires directly to TRO unit.

BACnet Model

Model	Options
TROB24T4XYZ1	BACnet

Stand-Alone Models

Model	Options
TRO24T4XYZ1	
TRO24T4XYZ3	Scheduler
TRO24-EXT1	Extended setpoint range

Applications

Ideal for existing installations and retrofits that already have an actuator mounted on the VAV box.



TRO54 Stand-Alone Models

Model	Analog outputs	TPM/Digital outputs	Sensor inputs
TRO5404	4	1 TPM	2
TRO54P3X1	2	3 Digital	2
Middle East and Asian Markets			
TRO5404-OE1	4	1 TPM	2

Inputs

AI3

3 Analog*



24Vac

Outputs

BO4

4 TRIACs*

A02

2 Analog*

Communication

BAC

BACnet
MS/TP

*Configurable



Main Features

- Programmable PI function
- Selectable proportional control band and dead band
- Pressure sensor input with air flow program
- Selectable internal or external temperature sensor
- Changeover by contact or external temperature sensor
- Freeze protection
- Backlit LCD with simple icon and text driven menus
- Selectable Fahrenheit or Celsius scale
- Manual Night set back override
- Multi level lockable access menu and setpoint

Main Features

- 24Vac operation
- Backlit LCD with simple icon and text driven menus
- Selectable Fahrenheit or Celsius scale
- "Night Set Back" mode with manual override
- Multi level lockable access menu and setpoint
- Selectable internal or external temperature sensor
- Selectable proportional control band

TUUB



Universal Wall Mount Controller

NEW



Packaged AC
Rooftop Units



Heat Pumps



Fan Coils

Inputs

A14

4 Analog*
(Universal)



24Vac

Outputs

B06

6 Binary*

A04

4 Analog*



1, 2, or 3* Speed
or ECM

Communication

BAC

BACnet
MS/TP

*Configurable

Mod

Modbus
RTU Slave

Models

Models	Temp.	RH	CO ₂	PIR	VOC
● TUUB00-100 ● TUUB30-100 ○ TUUB60-100	•				
● TUUB00-101 ● TUUB30-101 ○ TUUB60-101	•	•			
● TUUB00-102 ● TUUB30-102 ○ TUUB60-102	•	•	•		
● TUUB00-104 ● TUUB30-104 ○ TUUB60-104	•			•	
● TUUB00-105 ● TUUB30-105 ○ TUUB60-105	•	•		•	
● TUUB00-106 ● TUUB30-106 ○ TUUB60-106	•	•	•		•
● TUUB00-107 ● TUUB30-107 ○ TUUB60-107	•	•	•	•	•

Main Features

- Optional internal/external humidity sensor input for simple and accurate humidity control
- Internal/external occupancy input
- Optional built-in CO₂ and VOC sensors
- Output selector jumper to switch between B07 and A01
- Dehumidification sequence compensated by auto activation of reheat output
- Real time clock (RTC) with 24-hour backup
- Precise temperature control with configurable PI (Proportional-Integral) function
- Selectable internal or external temperature sensor
- Low limit set protection (10°C/50°F)
- Occupancy and night set back (NSB) mode
- Selectable direction on outputs
- Option of pulse/floating/on-off output on binary outputs
- Internal/external occupancy input
- Compressor anti-cycling delay (configurable)
- ΔT control (on request)
- BACnet MS/TP or Modbus communication (selectable)

Universal Applications

- Fan coil units (2 or 4 pipes)
- Rooftop units
- Heat pumps
- Humidity control
- Packaged or split unitary systems
- Other heating/cooling equipment

ARO/AROB



IAQ Wall Mount Controller

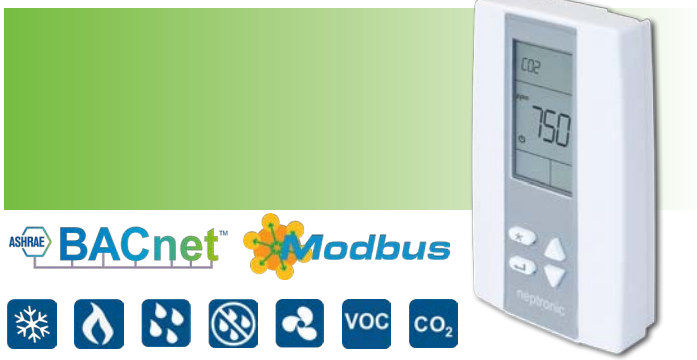

ASHRAE **BACnet**™ **Modbus**



Stand-Alone Models

Model	Temp.	RH	CO ₂	VOC
ARO24T	•			
ARO24TH	•	•		
ARO24TGH	•	•	•	
ARO24TGVH	•	•	•	•

Networkable Models

Model	Temp.	RH	CO ₂	VOC
AROB24T	•			
AROB24TH	•	•		
AROB24TGH	•	•	•	
AROB24TGVH	•	•	•	•

Inputs

BI1

1 Binary*

AI1

1 Analog

Outputs

B02

2 Binary*

A02

2 Analog*



ECM

Communication

BAC

BACnet
MS/TP

*Configurable

Mod

Modbus
RTU Slave

Main Features

- Built-in application profiles to automatically configure the controller for the selected application.
- Up to 4 simultaneous control loops
- Integrated ECM fan control mode
- Displays temperature, %RH, CO₂, VOC, and setpoints
- Display or hide all the required access for user interaction
- Precise temperature control with programmable PI function
- Independent cool and heat setpoint for No Occupancy

HROB20



Humidity Control Wall Mount Controller



ASHRAE **BACnet**™



Applications

- Neptronic SKR, SKE4, SKS4, and SKG4 humidifiers
- Other humidification and dehumidification applications

Main Features

- BACnet MS/TP (stand-alone model HRO20 also available)
- 4 analog outputs and 2 dry contact outputs
- 2 configurable analog inputs
- Window or external temperature sensor input
- Alarm status and low signal selector input
- Independently configure PID on humidify & dehumidify ramps
- Adjustable setpoint with auto reset from external sensor
- Multi level lockable access menu, setpoint and control mode

CMMB100

I/O

Dual Mini Input Module Expansion Controller

NEW



ASHRAE BACnet™

Modbus

Input expansion board (CMMB)

Inputs

AI8

8 Analog*
(Universal)



24Vac/
24Vdc

Communication

BAC

BACnet
MS/TP

*Configurable

Mod

Modbus
RTU Slave

Main Features

- BACnet MS/TP or Modbus communication (selectable)
- LED status indication of each input
- DIN rail mounting
- Removable see-through panel for easy access to DIP switches
- Optional plug-in connectors allowing for expansion

Models

Model	Inputs	Expansion Plug-in Connectors
CMMB100	8	
CMMB100E	8	•

CMMB102

I/O

Dual Mini I/O Module Expansion Controller

NEW



ASHRAE BACnet™

Modbus

Input and output expansion board (CMMB)

Inputs

AI4

4 Analog*
(Universal)



24Vac/
24Vdc

Outputs

BO2

2 Binary*

A02

2 Analog*
(Universal)

SW

4 Override
Switches

Communication

BAC

BACnet
MS/TP

*Configurable

Mod

Modbus
RTU Slave

Models

Model	Inputs	Outputs	Expansion Plug-in Connectors
CMMB102	4	4	
CMMB102E	4	4	•

Main Features

- BACnet MS/TP or Modbus communication (selectable)
- 4 override switches to manually control each output
- LED status indication of each input and output
- DIN rail mounting
- Removable see-through panel for easy access to DIP switches
- Optional plug-in connectors allowing for expansion

CMMB106

I/O

Dual Pro I/O Module Expansion Controller

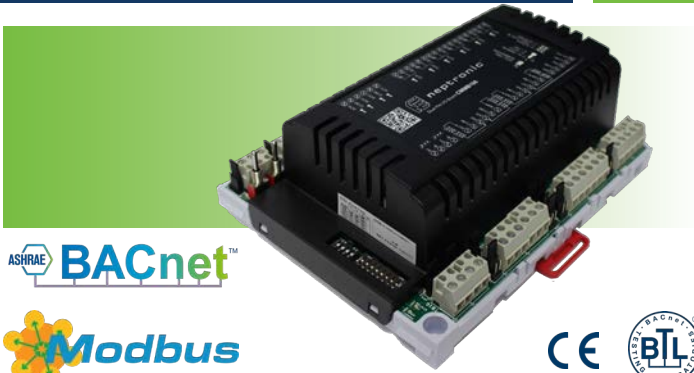

ASHRAE **BACnet**™

Modbus



 Input and output expansion board (CMMB)

Inputs

DI2

2 Digital*

AI8

8 Analog*
(Universal)



24Vac/
30Vdc

Outputs

DO6

6 Digital*

AO4

4 Analog*

SW

10 Override
Switches

Communication

BAC

BACnet
MS/TP

*Configurable

Mod

Modbus
RTU Slave

Models

Type	Model	Buttons	Inputs	Outputs
Exp. Board	CMMB106		10	10
Thermostat	STLD24A	Fan & heat-cool	1	
Thermostat	STLD24B	Fan & °F/°C	1	

Expansion Board (CMMB)

- BACnet MS/TP or Modbus communication (selectable)
- 10 inputs and 10 supervised outputs
- 10 override switches to manually control each output
- LED status indication of each input and output
- DIN rail mounting

Room Thermostat (STLD)

- User Interface fully customizable via Modbus RTU
- Backlit LCD with simple icon and text driven menus
- Built-in temperature sensor
- External temperature sensor input (10 KΩ)
- Selectable Fahrenheit or Celsius scale
- Set Modbus RTU baud rate via thermostat menu (9600, 19200, 38400 or 57600 bps)
- Set Modbus RTU address via thermostat menu or via DIPswitch



Inputs

BI2

2 Binary*

AI8

8 Analog*
(Universal)



24Vac/
24Vdc

Outputs

BO6

6 Binary*

AO4

4 Analog*

SW

10 Override
Switches

Communication

BAC

BACnet
MS/TP, IP
**Configurable*

Mod

Modbus
RTU Slave,
TCP/IP

IP

IP
Network &
Web Services

Models

Model	Router	Display	Communication Ports	
			BACnet Ports	Modbus Ports
CMMB-IP			1	1
CMMB-IP-L		•	1	1
CMMB-IP-R1B	•		1	
CMMB-IP-R2B	•		2	
CMMB-IP-RL1B	•	•	1	
CMMB-IP-RL2B	•	•	2	

Features

Power & Communication

- 24Vac or 24Vdc supply
- Up to 2 RS-485 communication ports for BACnet MS/TP or Modbus RTU
- BACnet IP/Ethernet or Modbus TCP/IP
- Set network settings via embedded WEB server
- Provision for I/O expansion modules
- Router functionality (optional)

10 Inputs

- 2 binary inputs
- 8 universal inputs

10 Outputs

- 6 binary outputs
- 4 analog outputs
- Supervised manual override of outputs via local web page or local dip switches

Other

- SD card slot for updates
- USB port for 5 Vdc power supply
- RJ45 Ethernet connection for IP and WEB services
- Optional LCD display

Network Communication

BACnet MS/TP

- MS/TP @ 9600, 19200, 38400 or 76800 bps
- Automatic baud rate detection
- Automatic device instance configuration

BACnet IP/Ethernet

- All IP/Ethernet configuration via on board WEB page
- Display device status including each available data point, in addition to the BACnet object interface
- Supports DHCP or fixed/static addressing

Modbus RTU

- Modbus @ 9600, 19200, 38400 or 57600 bps
- RTU Slave, 8 bits (configurable parity and stop bits)
- Connects to any Modbus master

Modbus TCP/IP

- Connects to any Modbus TCP/IP master controller

CMMB1322

I/O

Mini I/O Module Expansion Controller



ASHRAE **BACnet™**

 Input and output expansion board (CMMB)

Models

Type	Network	Inputs	Outputs
CMMB1322	BACnet MS/TP	2	2

Main Features

- BACnet MS/TP
- 2 inputs and 2 supervised outputs
- 2 override switches to manually control each output
- 120Vac or 240 Vac selectable power input
- 2 auxiliary outputs (24Vdc / 24Vac)

Inputs

AI2

2 Analog*
(Universal)



120 or 240Vac
(selectable)

Outputs

BO2

2 Binary*

SW

2 Override
Switches



24Vdc and 24Vac
(aux. output)

Communication

BAC

BACnet
MS/TP

*Configurable

RPB



BACnet Router

NEW



ASHRAE **BACnet™**

Models

Model	Description	Devices
RPB11	1-Port BACnet	Up to 32
RPB12	2-Port BACnet	Up to 64

Main Features

- One page, set-and-forget configuration and unique network discovery capabilities minimize installation time
- Up to 32 or 64 BACnet devices without the use of additional line drivers
- Simple web based configuration for BACnet IP and MS/TP communication
- Lowest cost per connected MS/TP device
- Lowest response time per connected MS/TP device
- Built-in network diagnostics
- Connect using Expansion slot to convert CMMB100E and CMMB102E as IP I/O cards
- Support up to 3 mini I/O cards in any combination and make them IP ready while maintaining the 2 MS/TP ports for BACnet routing

Inputs



24Vac

Communication

BAC

BACnet
MS/TP

Typical System Architecture

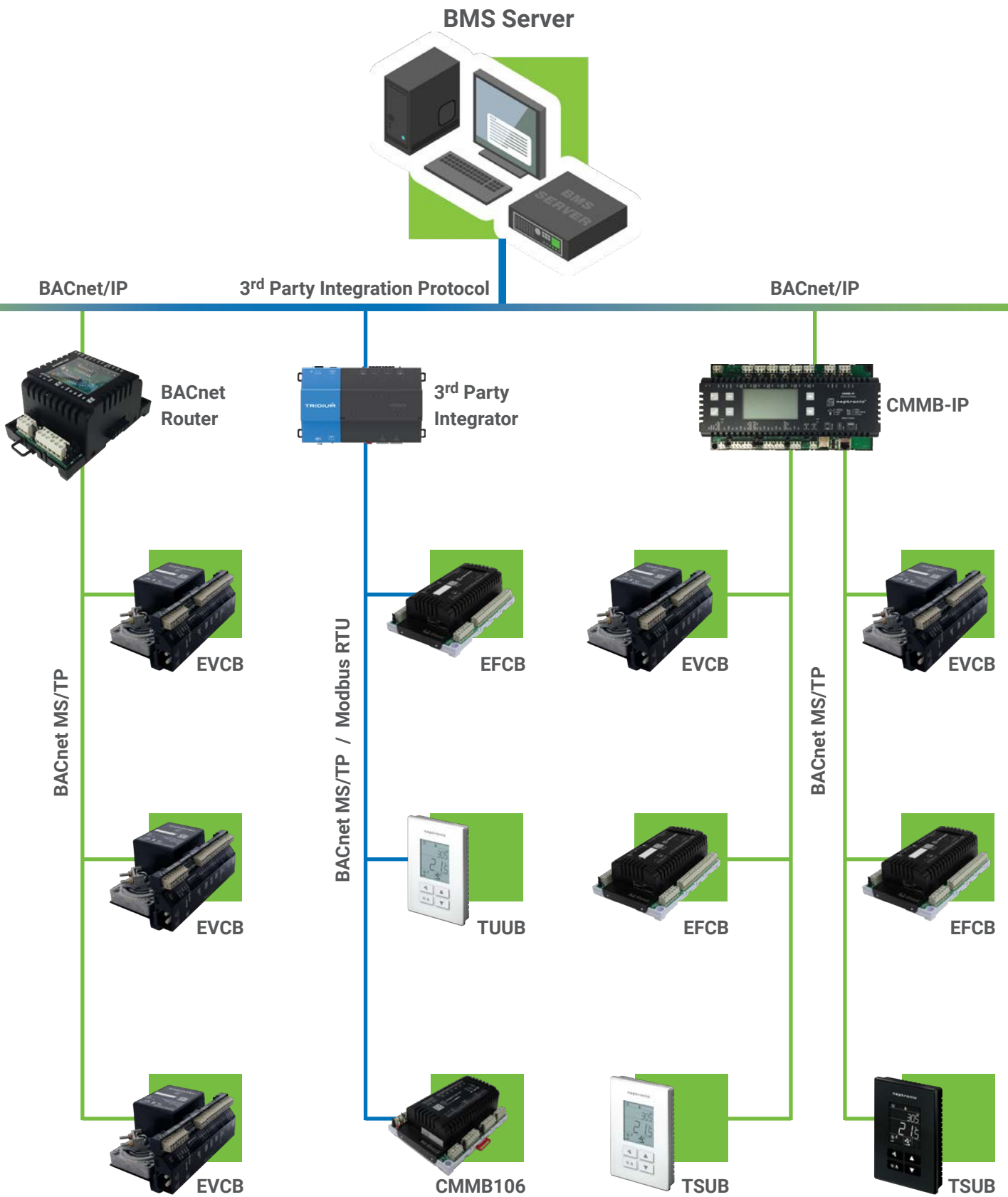

SARB



Networkable IAQ Room Sensors



Inputs

- BI1**
1 Binary
- AI1**
1 Analog
- 24Vdc/
24Vac

Outputs

- BO2**
2 Binary*
- AO2**
2 Analog*

Communication

- BAC**
BACnet
MS/TP
 - Mod**
Modbus
RTU Slave
- *Outputs commandable via network*

Models

Model	Temp.	RH	CO ₂	VOC
SARB24T	•			
SARB24TH	•	•		
SARB24TG	•		•	
SARB24TV	•			•
SARB24TGH	•	•	•	
SARB24TGVH	•	•	•	•

Main Features

- 2 inputs and 4 outputs commandable via network
- Enthalpy and dew point calculations (available via network)
- Display or hide all the required access for user interaction
- Backlit LCD with simple icon and text-driven menus
- Selectable Fahrenheit or Celsius scale
- BACnet® MS/TP or Modbus (selectable via menu)
- Select MAC address via menu or via network
- Automatic baud rate detection
- Network service port via on-board mini USB connector

SAR



IAQ Room Sensors



Models

Model	Temp.	RH	CO ₂	VOC
SAR24GH		•	•	
SAR24GV			•	•

Main Features

- CO₂ sensor feedback output (A01)
- CO₂ warning and alarm level outputs (BO1 and BO2)
- Humidity or VOC sensor feedback output (A02)
- Input voltage 24Vac or 24Vdc

Sensors



Humidity



SHC80: Duct Mount Humidity Sensor

- Duct mounted humidity sensor
- Built-in temperature sensor
- 2 analog outputs (0 - 10 Vdc)
- Status LED

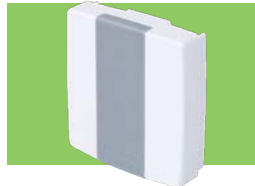

SHR10: Wall Mount Humidity Sensor

- Wall mounted humidity sensor
- Built-in temperature sensor
- Plastic cover for wall mount installation
- 2 analog outputs (0 - 10 Vdc)
- High accuracy and stability



SHS80: Duct Mount, High Limit Humidistat

- Built-in temperature and humidity sensor
- On/Off high limit humidistat with on-board setpoint adjustment
- 2 analog outputs (0-10 Vdc)
- Status and high limit LEDs
- 1 dry contact output



HRL24: Room Humidistat

- Used to program the SK4 series humidifiers
- Icon-driven information and 1 line of text information
- 4 wires between humidistat and SK4
- Programmable PID on humidity



SHS20: Room High Limit Humidistat

- High-limit setpoint dial (20 - 90% RH)
- Built-in humidity sensor
- 24Vac or 24Vdc
- 1 dry contact output



HRC20: Room Humidistat

- Humidity setpoint dial (10-60 %RH)
- Built-in humidity sensor
- 24Vac or 24Vdc
- 1 dry contact output

Sensors



Pressure



Model	Pressure Range
SPC 0.1	0 to 0.1" w.c.[25 Pa]
SPC 1.0	0 to 1.0" w.c.[250 Pa]
SPC 2.0	0 to 2.0" w.c.[500 Pa]
SPC 5.0	0 to 5.0" w.c.[1245 Pa]

SPC: Static Pressure Controller

- Simple installation and configuration
- Displays actual pressure reading
- Adjustable setpoint, dead band and response speed
- Selectable output signal
- Direct or reverse action outputs
- Fully calibrated
- Real-time pressure output for remote monitoring



Model	Pressure Range	Enclosure
SPD00-010	0-1" w.c.[250 Pa]	PCB only
SPD70-010	0-1" w.c.[250 Pa]	Metal enclosure
SPD00-020	0-2" w.c.[500 Pa]	PCB only
SPD70-020	0-2" w.c.[500 Pa]	Metal enclosure
SPD00-050	0-5" w.c.[1245 Pa]	PCB only
SPD70-050	0-5" w.c.[1245 Pa]	Metal enclosure

SPD: Static Pressure Differential Transducer

- Small footprint
- Simple and easy to install
- Selectable output signal (0-10 or 2-10 Vdc & 4-20 or 0-20mA)
- High flow impedance in the range of tens to hundreds of kPa

Sensors



Temperature



STC8: Duct Mount Temperature Sensor

- High accuracy and stability
- Fast thermal response
- Epoxy encapsulated sensor
- Extended durability
- Resistor/Temperature Curve
 - "G" matched (STC8-11, 10K Ω)
 - "A" matched (STC8-13, 3.3 K Ω)
- Compatible with Nepronic controllers

STC8-11	10K Ω
STC8-13	3.3K Ω
STC80X	Analog



STR1: Wall Mount Temperature Sensor

- Available with 10K Ω or 3.3K Ω thermistor
- High accuracy and stability
- Negative Temperature Coefficient (NTC)
- Compatible with Nepronic products

STR1-11	10K Ω
STR1-13	3.3K Ω



STP: Strap-On Water Temperature Sensor

- High accuracy and stability
- 10K Ω Type III Thermistor
- Designed for fan coil 2 pipe changeover applications
- Sensitive to non-polarity
- Temperature range: -40°C to 150°C (-40°F to 302°F)

STP7-11	Metal
STP1-11	Plastic



STI1-11: Immersion Water Temperature Sensor

- 10K Ω Type III Thermistor
- Immersion type temperature sensor
- Double encapsulation sensor eliminates moisture infiltration
- Machined 5 Brass thermowell
 - ABS plastic enclosure
 - Quick snap latch



OTW/SHW: Window Temperature Sensor

- 10K Ω (SHW0-11) or 3.3K Ω (OTW) temperature sensor
- Self adhesive: sticks directly on window

Accessories

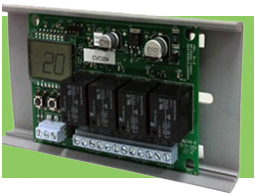

CVC

- 24Vac or 24 Vdc supply
- 2 or 4 SPDT relays (staged or sequenced operation)
- Voltage or current input
- Adjustable relay setpoint, hysteresis and activation delay
- Input signal management (loss of signal)
- Displays input voltage or current
- LED status indication of each relay
- Snap Track mounting
- Non-strip, raising clam terminals

Model	Relays
CVC002	2
CVC004	4



SCC80: Changeover Control Sensor

- 24Vac or 24 Vdc supply
- Sensor operation temperature up to 80°C [176°F]
- Fast response, excellent accuracy
- SPDT output relay
- No adjustments required (pre-calibrated)
- Built-in mounting tabs and mounting screws supplied for easy installation
- Status LED



Comes with male/female collar

Total connector pressure output is routed behind probe to minimize pressure loss and noise

Bullet shaped averaging chamber for low pressure loss and noise

3/16" Static pressure signal amplification ring

Equal area total pressure port

Static pressure connector output routed behind probe to minimize loss and noise

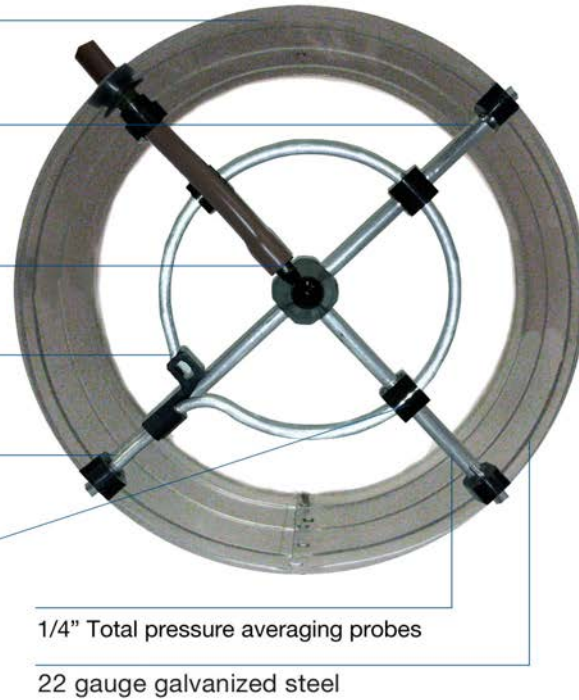

1/4" Total pressure averaging probes

22 gauge galvanized steel

Air Flow Stations

Mechanically amplifies the differential pressure signal making air velocity measurement in VAV boxes possible.

Main Features

- Mechanical amplification of differential pressure signal
- 2 outputs (total pressure and static pressure)
- Advanced design minimizes pressure loss and white noise

Models

Description	CF-06	CF-08	CF-10	CF-12	CF-14	CF-16
Inlet Diameter	6" (15.25 cm)	8" (20.30 cm)	10" (25.40 cm)	12" (30.50 cm)	14" (35.56 cm)	16" (40.64 cm)
Area	0.196 ft ² (0.018 m ²)	0.349 ft ² (0.032 m ²)	0.545 ft ² (0.050 m ²)	0.785 ft ² (0.073 m ²)	1.069 ft ² (0.099 m ²)	1.396 ft ² (0.130 m ²)
Velocity Constant	2812 FPM (14.3 m/s)	2740 FPM (13.9 m/s)	2841 FPM (14.4 m/s)	2822 FPM (14.3 m/s)	2666 FPM (13.5 m/s)	2837 FPM (14.4 m/s)
Velocity Pressure Constant	0.49	0.47	0.50	0.49	0.45	0.50
K Factor	552 CFM (261 l/s)	956 CFM (451 l/s)	1550 CFM (732 l/s)	2216 CFM (1046 l/s)	2850 CFM (1345 l/s)	3961 CFM (1869 l/s)
Amplification Factor F	2.60	2.30	2.30	2.15	2.15	2.10
Total Pressure Ports (ASHRAE Standard 62)	12	12	16	16	20	20
Velocity Range	300 to 3,000 FPM (1.5 to 15.2 m/s)					
Temperature Range	-40°C to 80°C (-40°F to 176°F)					
Materials	Aluminum & PC/ABS					



ACTUATORS

**Up to 70in.lb
(8Nm)**



D-B-S

- 35in.lb (4Nm) to 70in.lb (8Nm)

**Up to 360in.lb
(40Nm)**



L-T-R

- 140in.lb (16Nm) to 360in.lb (40Nm)

**Up to 4000in.lb
(450Nm)**



U & W

- 1800in.lb (200Nm) to 4000in.lb (450Nm)

Fast



B-T-R

- Running time of 1.5sec to 30sec

Smoke Damper



BTX-LX

- Rated at 250°F (121°C)

Outdoor



IP65

- High humidity and outdoor applications

Linear



A-V-X

- Zone, globe and PIC valve applications

ACTUATED VALVES

**Contoured
Port Ball**



Zone



Full Port Ball



Globe



Industrial Ball

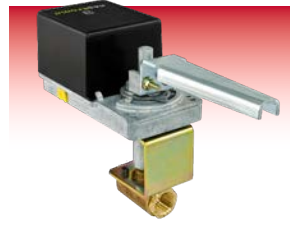

Retro Fit



Butterfly



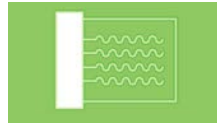

HECB Networkable Controller



BENEFITS

Save Energy

- Embedded and configurable energy conservation strategies
- Automatic or dynamic load shedding
- Limit electric heater consumption based on multiple variables
- Provides real-time temperature measures and power consumption data

Save Time

- View heater status and alarms remotely via network or thermostat
- Remote monitoring (status, alarms, diagnostics, and trending)
- Wall-mount remote user interface (view temperature, setpoint, heater status and alarms)

Integrate

- Integrate with BMS and intelligent buildings via BACnet MS/TP or Modbus
- Multiple BACnet/Modbus points to propel you towards the Internet of Things (IoT)
- Ensure better management of energy consumption for the future

Standard Features

- Accepts any industry standard input signal
- Quick and simple input signal selection via DIP switches
- Modulating, on/off, and/or up to 10 stages
- Real-time feedback output of heater capacity
- Automatic PID
- Remote feedback with TDU LCD thermostat (eliminates the use of expensive staged thermostats)
- Zero voltage crossing SSR
- Patented EAS Electronic Air Flow Sensors (US 7,012,223)

Network Communication

- BACnet MS/TP or Modbus RTU (selectable via DIP switch)
- Select MAC address via DIP switch or via network

BACnet MS/TP

- MS/TP @9600, 19200, 38400 or 76800 bps
- BACnet scheduler (up to 6 events)
- Firmware upgradeable via network
- COV (change of value)
- Copy and broadcast configuration to other HECB controllers via menu or network
- Automatic baud rate detection
- Automatic device instance configuration

Modbus RTU

- Modbus RTU @9600, 19200, 38400 or 57600 bps
- RTU Slave, 8 bits (configurable parity and stop bits)
- Connects to any Modbus RTU master

MANUFACTURER OF 

-  HVAC CONTROLS
-  ELECTRIC ACTUATORS
-  ACTUATED VALVES
-  HUMIDIFIERS
-  ELECTRIC HEATERS

neptronic.com